

REPAIR INSTRUCTIONS

LP301A/LP301A-SSP/LP301A-4000/LP600/LP600-4000

NOTE: Always take time to lubricate all metal and non-metal parts with a light film of oil before reassembling. This step will help ensure proper fit, at the same time protecting the pump non-metal parts (elastomers) from cutting and scoring.

TO CHECK VALVES

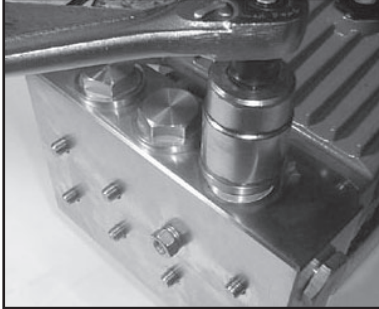

- 1) Loosen and remove tension plugs (48) with a 36mm socket wrench.

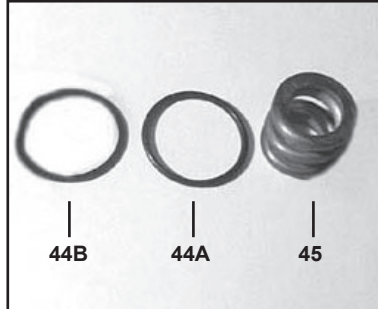

- 2) Remove the support ring (44B), O-ring (44A) and tension spring (45).

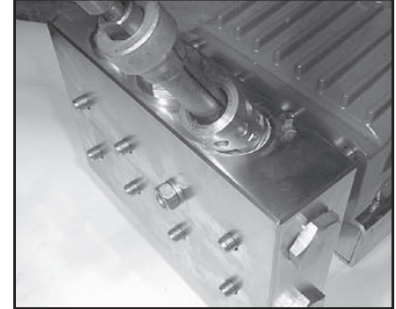

- 3) Take out discharge valve assemblies (46) by pulling them upwards out of the valve casing (43) with a snap-ring tongs or any other pull-off device. Then remove inlet valves in the same way.

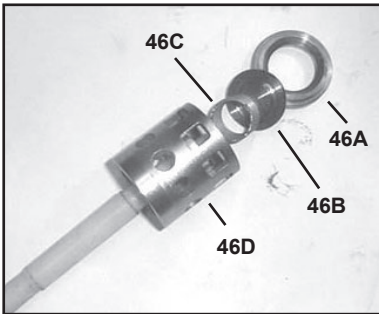

- 4) Loosen valve seats (46A) and valve spring (46C) from spacer pipe (46D) by lightly hitting the valve plate (46B) with a plastic stick. LP600/LP600-4000 pumps have an additional valve spring guide (46E). Check sealing surface and replace worn parts. Reassemble with new O-rings (44A) if possible and oil them before installing.

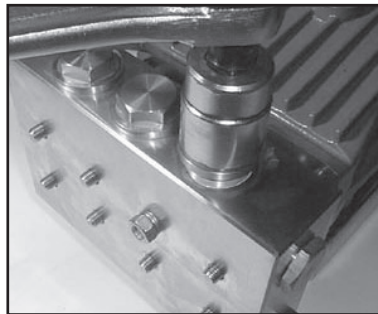

- 5) Tighten up tension plugs (48) to 107 ft.-lbs. (145 NM)

REPAIR INSTRUCTIONS

LP301A/LP301A-SSP/LP301A-4000/LP600/LP600-4000

NOTE: Always take time to lubricate all metal and non-metal parts with a light film of oil before reassembling. This step will help ensure proper fit, at the same time protecting the pump non-metal parts (elastomers) from cutting and scoring.

TO CHECK SEALS AND PLUNGER PIPE

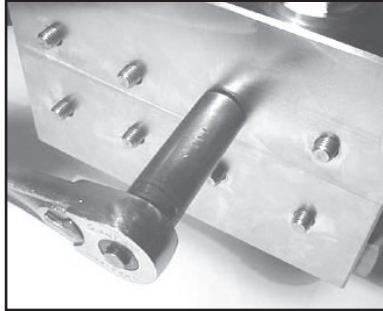

6) Loosen the 8 nuts (49A) with a 19mm socket and pull off valve casing (43) to the front.

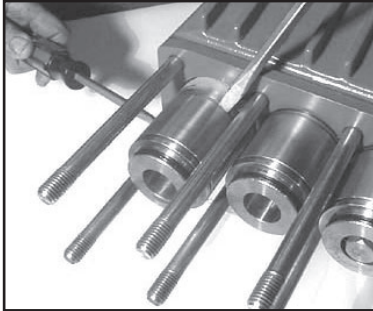

7) Remove the seal sleeve (35) from the manifold and /or crankcase.

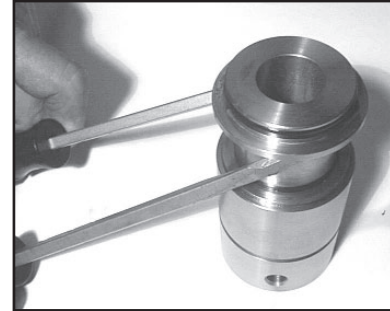

8) Remove seal case (37) from seal sleeve (35).

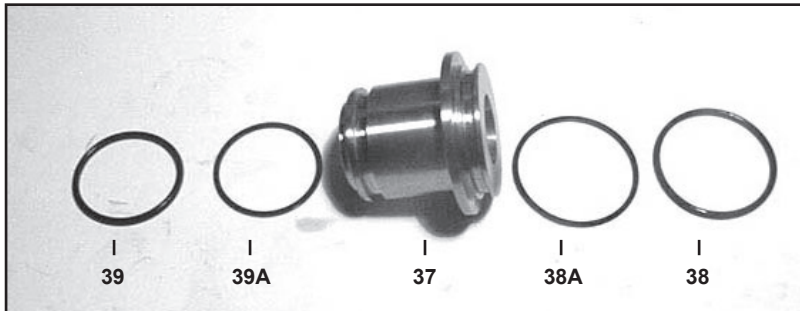

9) Check O-rings (39 & 38) and support rings (39A & 38A) on seal case (37).

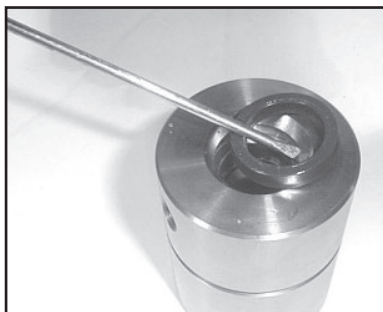

10) Remove leakage seal (36) from the seal sleeve. If worn or damaged replace with new seal.

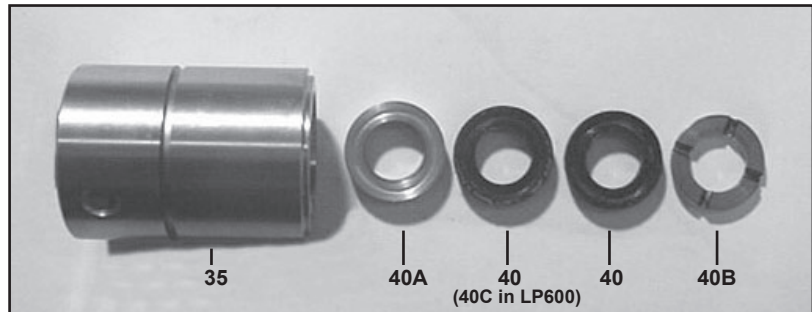

11) Remove the pressure ring (40A), v-sleeves (40), sleeve (40C in LP600 only), and support ring (40B), from the seal sleeve. For LP301A and LP301A-4000 pumps, remove the pressure spring (41). Examine seals carefully and replace if worn. Clean surfaces of seal sleeves (35) which come in contact with the crankcase (1) and sealing surfaces of valve casing (43).

REPAIR INSTRUCTIONS

LP301A/LP301A-SSP/LP301A-4000/LP600/LP600-4000

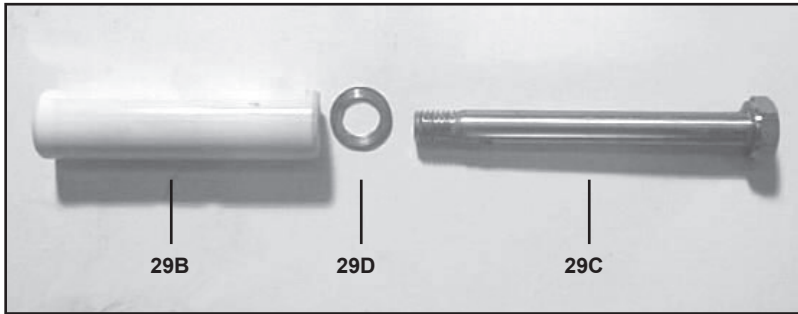

12) Check plunger surface (29B). If plunger pipe is worn out, loosen tension screws (29C) with a 15mm socket and pull off plunger pipe to the front. Clean front surface of plunger (29B) thoroughly. Apply a small drop of locktite to tension screw. Put a **new** crush washer (29D) onto tension screw. Put a thin coat of glue (Loctite) on the ring (or ceramic plunger side) and tighten screw to 265 in.-lbs. (30 NM).

13) Replace complete seal sleeve (35)/seal case (37) assembly into crankcase (1). Make sure that the weep hole points downward. **Note: To replace the oil seals (31), you will need to disassemble the gear end (see instructions below).**

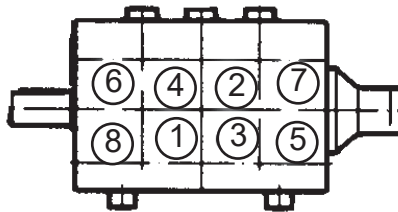
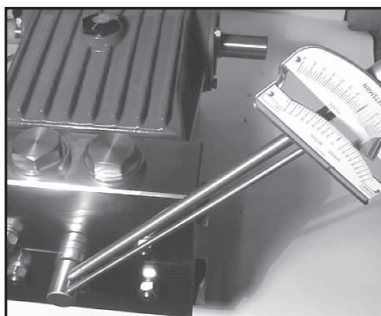

14) Place entire manifold/seal sleeve assembly over the studs and push firmly until seated against the crankcase.

15) Tighten hex nuts (49A) in a crosswise pattern (shown above) to 59 ft.-lbs. (80 Nm).

REPAIR INSTRUCTIONS

LP301A/LP301A-SSP/LP301A-4000/LP600/LP600-4000

TO DISMANTLE GEAR END

After removing valve casing (43) and plunger pipe (29B), drain the oil. Remove the gear cover (4) and both bearing covers (14). Loosen connecting rod screws (24A) and push the front of the connecting rod (24) forward as far as possible into the crosshead guide.

IMPORTANT! Connecting rods (24) are marked for identification. Do not twist connecting rod halves. Connecting rod is to be reinstalled in the same position on shaft journals.

Turning the crankshaft (22) slightly, hit it out carefully to the side with a rubber hammer.

IMPORTANT! Do not bend the connecting rod (24) shanks. Check crankshaft (22) and connecting rod (24) surfaces, radial shaft seals (15) and taper roller bearings (20).

To remove the oil seals (31) use a wooden rod and sharply hit down on the oil seals from the crankcase (1). Note: when replacing the oil seals, apply a small amount of locktight to the outside edges of each oil seal before re-inserting them into the crankcase.

To Reassemble

Using a soft tool, press in the outer bearing ring until the outer edge lines up with the outer edge of the bearing hole. Remove bearing cover (14) together with radial shaft seal (15) and o-ring (16). Fit crankshaft (22) through bearing hole on the opposite side. Press in outer bearing and tighten it inwards with the bearing cover, keeping the crankshaft in vertical position and turning slowly so that the taper rollers of the bearings touch the edge of the outer bearing ring. Adjust axial bearing clearance to at least 0.1mm and maximum 0.15mm by placing fitting discs (20A and 20B) under the bearing cover.

IMPORTANT! After assembly has been completed, the crankshaft should turn easily with very little clearance. Tighten connecting rod screws (24A) to 22 ft.-lbs. (30 Nm) Re-assemble the fluid end (see instructions above).

LP301A/LP301A-SSP/LP301A-4000/LP600/LP600-4000			
TORQUE SPECIFICATIONS			
<u>Position</u>	<u>Item#</u>	<u>Description</u>	<u>Torque Amount</u>
1	07759	Crankcase (Molycoate-Copper Paste on sealing area - seal sleeves)	
6	05943	Oil Sight Glass w/Gasket (Loctite 572)	29 ft.-lbs. (40 Nm)
10	01010/01010-0100	Cylinder Screw	221 in.-lbs. (25 Nm)
12	07109	Plug, 1/2" BSP	29 ft.-lbs. (40 Nm)
17	07114/07114-0100	Hexagon Screw	221 in.-lbs. (25 Nm)
24A	13277	Inner Hex Screw, Connecting Rod	22 ft.-lbs. (30 Nm)
29C	13031 (LP600)	Tension Screw, Plunger (Loctite 243)	22 ft.-lbs. (30 Nm)
29C	13031 (LP301A)	Tension Screw, Plunger (Loctite 243)	26 ft.-lbs. (35 Nm)
29D	07755	Copper Ring (Loctite 577 on both sides)	
29D	07161-0100	Crush Washer (Loctite 577 on both sides)	
31	07133	Oil Seal (Loctite 403)	
48	06077	Plug, Discharge (Pro Pack 550)	107 ft.-lbs. (145 Nm)
49	07140	Stud Bolt (Small amount on crankcase side Loctite 270)	
49A	07158	Hexagon Nut, Stud Bolts	59 ft.-lbs. (80 Nm)

Pump Mounting Selection Guide

Bushings

06496 - 35 mm H Bushing

Pulley & Sheaves

07165 - 12.75" Cast Iron - 4 gr.
AB Section

Rails

07357 - Plated Steel Channel Rails
(L=11.75"x W=1.88"x H=3.00")