

# Series

## GP8155/GP8355

## GP8160/GP8360

## GP8165/GP8365

### GEARBOX SERIES

Triplex Ceramic  
Plunger Pump  
Operating Instructions  
Repair and Service Manual

GP8100 - Spheroidal Nickel-Plated Cast Iron Manifold  
GP8300 - Bronze Manifold

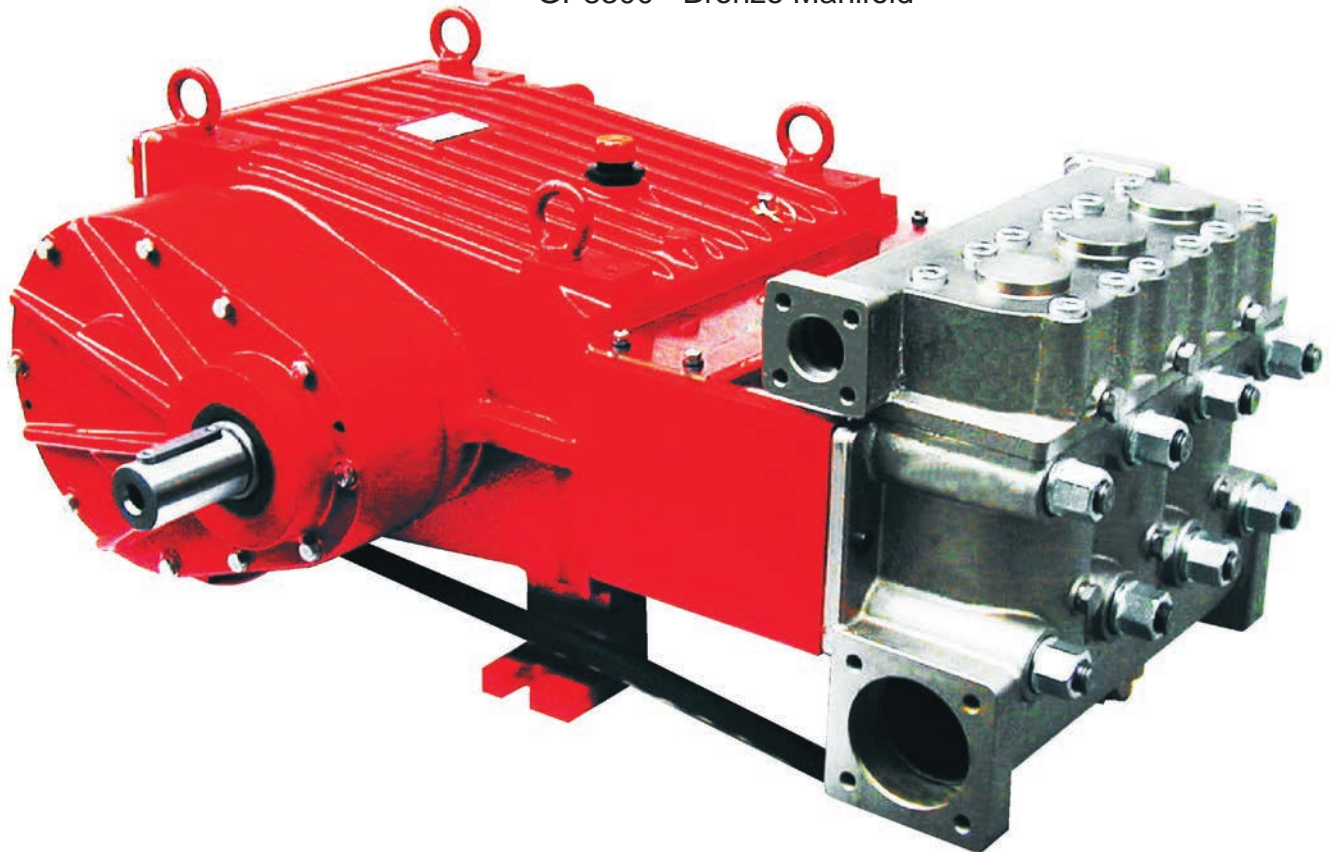

**GIANT**  
Performance Under Pressure

#### Contents:

Installation Instructions:	page 2
Operating Instructions:	page 3
GP8155 Pump Specifications:	page 4
GP8160 Pump Specifications:	page 5
GP8165 Pump Specifications:	page 8
Exploded View:	page 6
Parts List:	page 7
Repair Kits:	page 9
Tool List/Torque Specifications/ Troubleshooting Chart:	page 10
Repair Instructions:	pages 11-14
Dimensions:	page 15
Warranty Information:	back page

# INSTALLATION INSTRUCTIONS

**Installation of the Giant Industries, Inc., pump is not a complicated procedure, but there are some basic steps common to all pumps. The following information is to be considered as a general outline for installation. If you have unique requirements, please contact Giant Industries, Inc. or your local distributor for assistance.**

1. The pump should be installed flat on a base to a maximum of a 15 degree angle of inclination to ensure optimum lubrication.
2. Cavitation and/or compression of gases will lead to uncontrollable pressure spikes which can damage the pump and parts as well as cause injury to the operator or people nearby. The inlet to the pump should be sized for the flow rate of the pump with no unnecessary restrictions that can cause cavitation. If these pumps are to be operated at temperatures in excess of 86° F (30° C), be sure to contact Giant Industries. At higher temperatures it is important to insure a positive head (NPSH) to the pump to prevent cavitation. As the inlet temperature increases, the cooling system becomes less effective. For fluid temperatures above 120 °F (50 °C), an independent colling system should be installed.
3. The discharge plumbing from the pump should be properly sized to the flow rate to prevent line pressure loss to the work area. It is essential to provide a safety bypass valve between the pump and the work area to protect the pump from pressure spikes in the event of a blockage or the use of a shut-off gun. Teflon tape should be used to seal all joints.
4. Use of a dampener is necessary to minimize pulsation at drive elements, plumbing, connections, and other system areas. The use of a dampener with Giant Industries, Inc. pumps is optional, although recommended by Giant Industries, Inc. to further reduce system pulsation. Dampeners can also reduce the severity of pressure spikes that occur in systems using a shut-off gun. A dampener must be positioned downstream from the unloader.
5. Crankshaft rotation on Giant Industries, Inc. GP8100/GP8300 series pumps should be made in the direction designated by the black arrows on the pump gearcase. This is to ensure proper lubrication.

The preferred/optimal direction of rotation ensures the motion of the conrods correctly distributes the oil onto the crosshead guides - which is a particular advantage where continuous operation is involved.

The pump can also be run against the recommended direction of rotation if operated periodically or at reduced pressure. If so, the pump has to be run in this direction to smooth out bearing areas. This is done by a one-time operation at zero pressure for at least 30 minutes; thereafter the pressure must be slowly increased over the next hour to the desired max. operating pressure after which the pump is then run at this pressure. The oil temperature is to be checked during this procedure.

**Important!** During operation, all rotating parts, shaft(s) and coupling, must be covered by a protective guard. Plunger area must have the cover plate (30) secured in place. Do not step or place weight on the cover plate (30).

6. Before beginning operation of your pumping system, remember: Check that the crankcase and seal areas have been properly lubricated per recommended schedules. Do not run the pump dry for extended periods of time. Cavitation will result in severe damage. Always remember to check that all plumbing valves are open and that pumped media can flow freely to the inlet of the pump.

**Important!** The service life of the seals is maximized if a minimal amount of leakage is present. A few drops of water can drip from each plunger every minute. Leakage has to be examined every day; the plunger seals must be changed should leakage become excessive (i.e. constant dripping).

Finally, remember that high pressure operation in a pump system has many advantages. But, if it is used carelessly and without regard to its potential hazard, it can cause serious injury.

**Failure to comply with any of these conditions invalidates warranty**

# OPERATING INSTRUCTIONS

## IMPORTANT OPERATING INSTRUCTIONS

**Failure to comply with any of these conditions invalidates warranty**

1. Prior to initial operation, add oil to crankcase so that oil level is between the two lines on the oil dipstick. **DO NOT OVERFILL. Use Industrial gear lube oil (ISO VG 220 GL4), such as Mobil Gear 630, Shell Omala oil 220 or Texaco Meropa 220.** Crankcase oil should be changed after the first 50 hours of operation, then at regular intervals of 1000 hours or less depending on operating conditions. In either case, the oil should be changed once per year.

Run pump for one (1) min at ZERO PSI before operating under pressure.

**Important!** When operating in high humidity or wide temperature fluctuations, oil must be changed if condensate or frothy oil occurs in crankcase.

2. Pump operation must not exceed rated pressure, volume or RPM. A pressure relief device must be installed in the discharge of the system to prevent the rated pressure from exceeding 10%. NPSH values must be observed.

3. Giant Triplex Plunger Pumps are suitable for pumping clean water and other non-aggressive or non-abrasive liquids with a specific weight close, or equal, to water. All media to be filtered to 200 microns. Before pumping other media, such as acids, alkalines, abrasive, explosive or toxic fluids, Giant Industries, Inc. must be consulted and approval - if granted - provided in writing. It is the responsibility of the equipment operator and/or end user to ensure that all pertinent safety regulations are adhered to.

4. Run the pump dry approximately 10 seconds to drain the water before exposure to freezing temperatures.

**Important!** The pump and cooling system must be emptied if there is a danger of frost. Note that travel wind, for example, can cause water in pumps fitted on open vehicles to freeze even if the outside temperature is above freezing point.

To empty the cooling circuit, remove the L-joints (K11) on the pump head (50). Blow out the circuit liquid at the joint connection (K11/K7) using compressed air.

5. **Important!** Inlet pressure not to exceed 29 PSI (2 bar) when using the integrated oil cooling system. If using the separate cooling system, the inlet pressure can be a maximum of 145 PSI (10 bar). Make sure that the suction pulsation is sufficiently dampened; water column resonance must be avoided.

6. The torque tension on the valve casing nuts (49A) should be checked after approximately 200 operating hours. Pump must be at zero pressure. See page 10 for torque values.

## Specifications GP8155 Series/GP8355 Series

	<b>U.S.</b>	<b>(Metric)</b>
Volume.....	Up to 75.5 GPM	(285 LPM)
Discharge Pressure.....	Up to 3000 PSI	(200 bar)
Crankshaft Speed.....		Up to 580 RPM
Inlet Pressure .....	Up to 29 PSI	(2.0 bar)
Plunger Diameter.....	2.17"	55mm
Plunger Stroke.....	2.83"	72mm
Crankshaft Diameter.....	2.76"	70mm
Key Width .....	0.55"	14mm
Crankshaft Mounting .....		Either side
Shaft Rotation.....		See Page 2
Temperature of Pumped Fluids .....	Up to 86 °F	(30 °C)
Inlet Ports .....		(2) 3" BSP
Discharge Ports .....		(2) 1-1/4" BSP
Weight .....	794 lbs.	(360kg)
Crankcase Oil Capacity .....	4.2 Gal.	(16.0 liters)
Fluid End Material (GP8155).....	Nickle plated Spheroidal Cast Iron	
Fluid End Material (GP8355).....	Bronze	

(The specifications above are based on maximum pressure and maximum RPM for intermittent duty using cold water.)

<b>Model</b> .....	<b>Gear Ratio</b> .....	<b>Input Speed</b>
GP8155-2.6 .....	2.6:1.....	1500 RPM
GP8155-3.1 .....	3.1:1.....	1800 RPM
GP8155-3.8 .....	3.8:1.....	2200 RPM
GP8155-4.5 .....	4.5:1.....	2600 RPM

Consult the factory for special requirements that must be met if the pump is to operate beyond one or more of the limits specified above.

<b>GP8155/GP8355 Horsepower Requirements</b>					
RPM	GPM	500 PSI	1000 PI	2000 PSI	3000 PSI
300	39	13.9	27.9	55.7	83.6
400	52	18.6	37.1	74.3	111.4
500	65	23.2	46.4	92.9	139.3
580	75.5	27.0	53.9	107.9	161.8

**HORSEPOWER RATINGS:**  
The rating shown are the power requirements for the pump. Gas engine power outputs must be approximately twice the pump power requirements shown above.  
We recommend a 1.15 service factor be specified when selecting an electric motor as the power source. To compute specific pump horsepower requirements, use the following formula:

$$\frac{\text{GPM} \times \text{PSI}}{1450} = \text{HP}$$

**SPECIAL NOTE:**  
The theoretical gallons per revolution (gal/rev) is 0.130.  
To find specific outputs at various RPM, use the formula:

$$\text{GPM} = 0.130 \times \text{RPM}$$

## Specifications GP8160 Series/GP8360 Series

	U.S.	(Metric)
Volume.....	Up to 90 GPM .....	(341 LPM)
Discharge Pressure .....	Up to 2500 PSI .....	(172 bar)
Crankshaft Speed.....	.....	Up to 580 RPM
Inlet Pressure .....	Up to 29 PSI .....	(2.0 bar)
Plunger Diameter.....	2.36" .....	60mm
Plunger Stroke.....	2.83" .....	72mm
Crankshaft Diameter.....	2.76" .....	70mm
Key Width .....	0.55" .....	14mm
Crankshaft Mounting .....	.....	Either side
Shaft Rotation.....	.....	See Page 2
Temperature of Pumped Fluids .....	Up to 86 °F .....	(30 °C)
Inlet Ports .....	.....	(2) 3" BSP
Discharge Ports.....	.....	(2) 1-1/4" BSP
Weight .....	794 lbs.....	(360kg)
Crankcase Oil Capacity .....	4.2 Gal. ....	(16.0 liters)
Fluid End Material (GP8160) .....	Nickle plated Spheroidal Cast Iron	
Fluid End Material (GP8360) .....	Bronze	

(The specifications above are based on maximum pressure and maximum RPM for intermittent duty using cold water.)

<u>Model</u>	<u>Gear Ratio</u>	<u>Input Speed</u>
GP8160-2.6 .....	2.6:1 .....	1500 RPM
GP8160-3.1 .....	3.1:1 .....	1800 RPM
GP8160-3.8 .....	3.8:1 .....	2200 RPM
GP8160-4.5 .....	4.5:1 .....	2600 RPM

Consult the factory for special requirements that must be met if the pump is to operate beyond one or more of the limits specified above.

<b>GP8160/GP8360 Horsepower Requirements</b>					
RPM	GPM	500 PSI	1000 PSI	2000 PSI	3000 PSI
300	47	16.8	33.6	67.1	83.9
400	62	22.1	44.3	88.6	110.7
500	78	27.9	55.7	111.4	139.3
580	90	32.1	64.3	128.6	160.7

**HORSEPOWER RATINGS:**  
The rating shown are the power requirements for the pump. Gas engine power outputs must be approximately twice the pump power requirements shown above.  
We recommend a 1.15 service factor be specified when selecting an electric motor as the power source. To compute specific pump horsepower requirements, use the following formula:

**SPECIAL NOTE:**  
The theoretical gallons per revolution (gal/rev) is 0.155.  
To find specific outputs at various RPM, use the formula:

GPM = 0.155 x RPM

$$\frac{\text{GPM} \times \text{PSI}}{1450} = \text{HP}$$



## Specifications GP8165 Series/GP8365 Series

	U.S.	(Metric)
Volume.....	Up to 105 GPM .....	(400 LPM)
Discharge Pressure .....	Up to 2000 PSI .....	(140 bar)
Crankshaft Speed.....	.....	Up to 580 RPM
Inlet Pressure .....	Up to 29 PSI .....	(2.0 bar)
Plunger Diameter.....	2.55" .....	65mm
Plunger Stroke.....	2.83" .....	72mm
Crankshaft Diameter.....	2.76" .....	70mm
Key Width .....	0.55" .....	14mm
Crankshaft Mounting .....	.....	Either side
Shaft Rotation.....	.....	See Page 2
Temperature of Pumped Fluids .....	Up to 86 °F .....	(30 °C)
Inlet Ports .....	.....	(2) 3" BSP
Discharge Ports.....	.....	(2) 1-1/4" BSP
Weight .....	794 lbs.....	(360kg)
Crankcase Oil Capacity .....	4.2 Gal. ....	(16.0 liters)
Fluid End Material (GP8165) .....	Nickle plated Spheroidal Cast Iron	
Fluid End Material (GP8365) .....	Bronze	

(The specifications above are based on maximum pressure and maximum RPM for intermittent duty using cold water.)

<u>Model</u> .....	<u>Gear Ratio</u> .....	<u>Input Speed</u>
GP8165-2.6 .....	2.6:1 .....	1500 RPM
GP8165-3.1 .....	3.1:1 .....	1800 RPM
GP8165-3.8 .....	3.8:1 .....	2200 RPM
GP8165-4.5 .....	4.5:1 .....	2600 RPM

Consult the factory for special requirements that must be met if the pump is to operate beyond one or more of the limits specified above.

<b>GP8165/GP8365 HORSEPOWER REQUIREMENTS</b>					
RPM	GPM	500 PSI	750 PSI	1000 PSI	2000 PSI
300	54	18.6	27.9	37.2	74.5
400	72	24.8	37.2	49.7	99.3
500	91	31.4	47.1	62.8	125.5
580	105	36.2	54.3	72.4	144.8

**SPECIAL NOTE:**

The theoretical gallons per revolution (gal/rev) is 0.181.  
To find specific outputs at various RPM, use the formula:

$$\text{GPM} = 0.181 \times \text{RPM}$$

**HORSEPOWER RATINGS:**

The rating shown are the power requirements for the pump. Gas engine power outputs must be approximately twice the pump power requirements shown above.

We recommend a 1.15 service factor be specified when selecting an electric motor as the power source. To compute specific pump horsepower requirements, use the following formula:

$$\frac{\text{GPM} \times \text{PSI}}{1450} = \text{HP}$$

## Pump Repair Kits - GP8155/GP8355/GP8160/GP8360/GP8165/GP8365

### Plunger Packing Kit - GP8155/GP8355

# 09616

<u>Item</u>	<u>Part #</u>	<u>Description</u>	<u>Qty.</u>
38A	13286	O-Ring	6
38B	05281	Support Ring	6
39A	05066	O-Ring	3
40	07723	Seal Ring	3
42	05277	Sleeve	9

### Plunger Packing Kit - GP8160/GP8360

# 09617

<u>Item</u>	<u>Part #</u>	<u>Description</u>	<u>Qty.</u>
38A	06667	O-Ring	6
39A	05066	O-Ring	3
40	05067	Seal Ring	3
42	05069	Sleeve	9

### Plunger Packing Kit - GP8165/GP8365

# 09586

<u>Item</u>	<u>Part #</u>	<u>Description</u>	<u>Qty.</u>
38A	06667	O-Ring	6
39A	05066	O-Ring	3
40	06996	Seal Ring	3
42	06997	V-Sleeve	9

### Inlet Valve Kit

#09587

<u>Item</u>	<u>Part #</u>	<u>Description</u>	<u>Qty.</u>
51B	05078	Inlet Valve Seat	1
51C	05079	Valve Plate	1
51D	07658	O-Ring	1
51E	05080	Valve Spring	1
56A	06258	O-Ring	1

### Discharge Valve Kit

#09588

<u>Item</u>	<u>Part #</u>	<u>Description</u>	<u>Qty.</u>
52B	05084	Discharge Valve Seat	1
52C	05079	Valve Plate	1
52D	06258	O-Ring	2
52E	05080	Valve Spring	1
56A	06258	O-Ring	1

### Oil Seal Kit

#09584

<u>Item</u>	<u>Part #</u>	<u>Description</u>	<u>Qty.</u>
32	05058	Radial Shaft Seal	3
33A	05056	O-Ring	3

# Exploded View - GP8155/GP8355/GP8160/GP8360/GP8165/GP8365

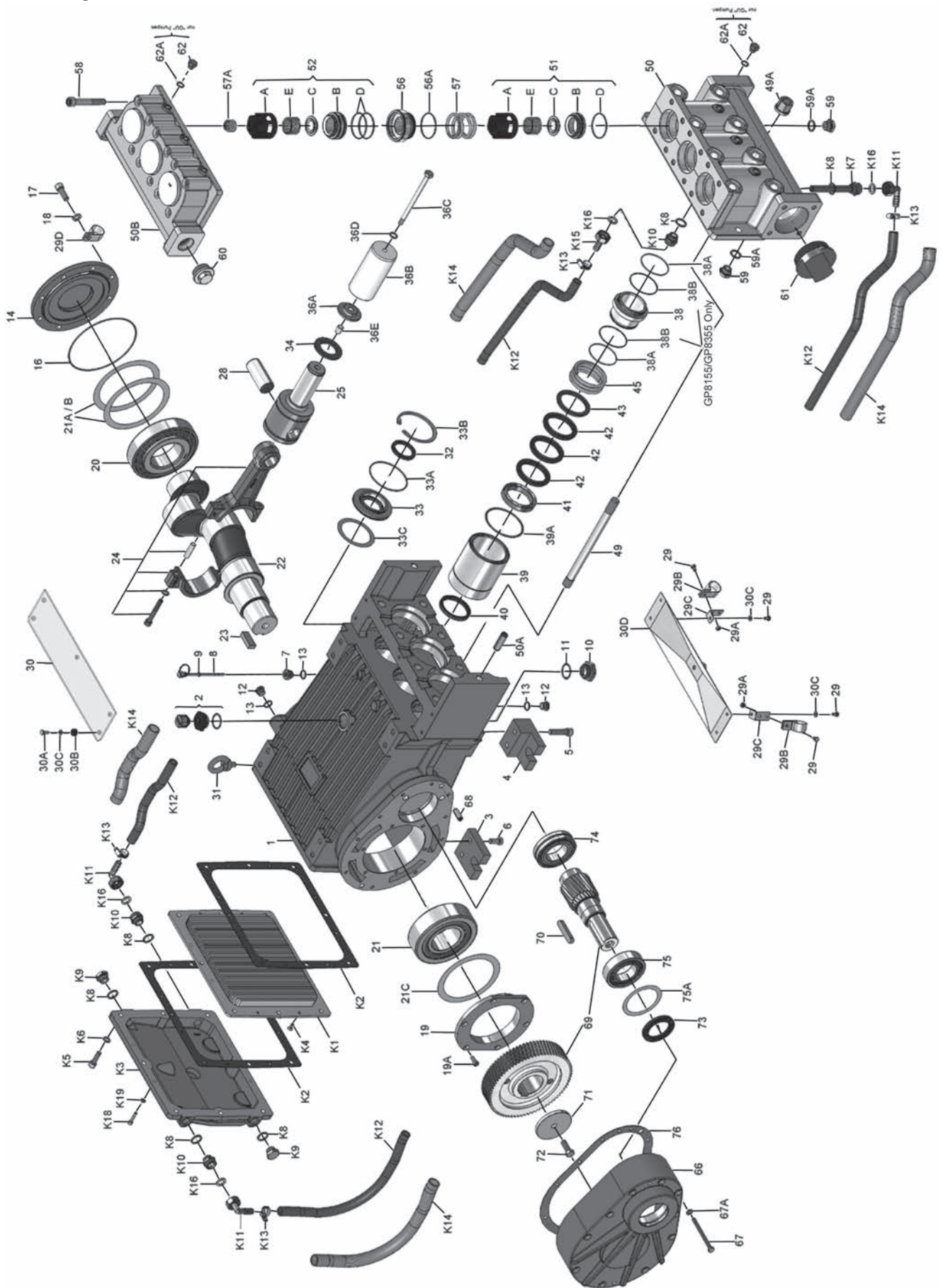



## Parts List - GP8155/GP8355/GP8160/GP8360/GP8165/GP8365

Item	Part	Description	Qty	Item	Part	Description	Qty
1	05651	Crankcase	1	45	05279	Seal Tension Spring, GP8155/GP8355	3
2	06893	Oil Filler Plug Assy with Vent	1				
3	05652	Rear Foot for Crankcase	2	45	05071	Seal Tension Spring, GP8160/GP8360	3
4	05653	Front Foot for Crankcase	2				
5	05654	Hexagon Socket Screw	4	45	05119	Seal Tension Spring, GP8165/GP8365	3
6	05655	Hexagon Socket Screw	4				
7	05656	Plug, 3/8" for Oil Dipstick	1	49	05072	Stud Bolt	8
8	04185	Oil Dipstick Assy	1	49A	05073	Hexagon Nut	8
9	01009	O-Ring	1	50	05074	Valve Casing, GP8155/GP8160/GP8165	1
10	05657	Plug M33 X 1.5	1				
11	07102	O-Ring	1	50	05074-3000	Valve Casing, GP8355/GP8360/GP8365	1
12	12256	Plug 3/8" BSP	3				
13	22929	Copper Washer	4	50A	13162	Centering Stud	2
14	05036	Bearing Cover Closed	1	50B	05075	Discharge Casing, GP8155/GP8160/GP8165	1
16	05037	O-Ring	1				
17	05038	Hexagon Socket Screw M12	8	50B	05075-3000	Discharge Valve Casing, GP8355/GP8360/GP8365	1
18	05039	Spring Ring	8				
19	05765	Flange	1	51	04186	Suction Valve Assy.	3
19A	05766	Hexagon Socket Screw	6	51A	04166	Spring Tension Cap	3
20	05658	Tapered Roller Bearing	1	51B	05078	Suction Valve Seat	3
21	05659	Tapered Roller Bearing	1	51C	05079	Valve Plate	3
21A	05042	Fitting Disc	3	51D	07658	O-Ring	3
21B	05043	Fitting Disc	3	51E	05080	Valve Spring	3
21C	05113	Fitting Disc	3	52	04188	Discharge Valve Assy	3
22	05741	Crankshaft For Gear	1	52A	04166	Spring Tension Cap	3
23	05661	Fitting Key	1	52B	05084	Discharge Valve Seat	3
24	05047	Conn-rod Assy	3	52C	05079	Valve Plate	3
25	05048	Crosshead c/w Plunger	3	52D	06258	O-Ring	6
28	05049	Crosshead Pin	3	52E	05080	Valve Spring	3
29	05051	Hexagon Screw	4	56	05085	Discharge Valve Adaptor	3
29A	07408	Hexagon Nut	2	56A	06258	O-Ring	3
29B	05383	Bracket 2 for Cooling Hose	2	57	05086	Pressure Spring	3
29C	05662	Support Clamp	2	57A	07210-0100	Pressure Spring	3
29D	05381	Bracket 1 for Cooling Hose	1	58	05087	Hexagon Socket Screw	12
30	05052	Cover Plate	1	59	07109	Plug, 1/2" BSP	2 (3*)
30A	07225-0100	Hexagon Screw	5	59A	06272	Copper Seal	2 (3*)
30B	13136	Grommet	5	60	06909	Plug, 1-1/4" BSP, GP8155/GP8160/GP8165	1
30C	08280	Washer	9				
30D	05050	Splash Cover	1	60	13151	Plug, 1-1/4" BSP, GP8355/GP8360/GP8365	1
31	07623	Eye Bolt	4				
32	05058	Radial Shaft Seal	3	61	05088	Plug, 3" BSP	1
33	05055	Seal Retainer	3	62	05302	Plug, 1/4" BSP	6
33A	05056	O-Ring	3	62A	06934	Copper Gasket	6
33B	05054	Clip Ring	3	66	05663	Gear Cover	1
33C	05059	Fitting Disc	3	67	05664	Hexagon Screw	10
34	05060	Oil Shield	3	67A	05341	Washer	10
36A	05063	Plunger Pipe Cover, GP8160/ GP8360/GP8165/GP8365	3	68	04445	Cylinder Pin	2
36B	05280	Plunger, GP8155/GP8355	3	69	04171	Gear Wheel Set (1500 RPM=2.6)	1
36B	05061	Plunger, GP8160/GP8360	3	69	04170	Gear Wheel Set (1800 RPM=3.1)	1
36B	05115	Plunger, GP8165/GP8365	3	69	05767	Gear Wheel Set (2200 RPM=3.8)	1
36C	05062	Tension Screw	3	70	05666	Gear Wheel Set (2600 RPM=4.5)	1
36D	07665	Copper Washer	3	71	07614	Fitting Key	1
36E	06900	Centering Sleeve	3	72	04571	Spacer Ring	1
38	05283	Seal Case, GP8155/GP8355	3	73	05667	Hexagon Screw	1
38	05064	Seal Case, GP8160/ GP8360/GP8165/GP8365	3	74	05608	Shaft Seal Ring for Gear	1
38A	13286	O-Ring, GP8155/GP8355	6	75	05668	Self-Aligning Roller Bearing	1
38A	06667	O-Ring, GP8160/ GP8360/GP8165/GP8365	6	75A	05669	Roller Bearing	1
38B	05281	Support Ring, GP8155/GP8355 Only	6	76	05670	Fitting Disc	1
39	05275	Seal Sleeve, GP8155/GP8355	3	77	05432	Gear Seal	1
39	05065	Seal Sleeve, GP8160/GP8360	3	78	05025	Oil Cooler (Items K1 - K19)	1
39	05116	Seal Sleeve, GP8165/GP8365	3	79	07662	Valve Puller (Not Shown)	1
39A	05066	O-Ring	3	K1	05026	Cooling Vane Plate	1
40	07723	Seal Ring, GP8155/GP8355	3	K2	05027	Seal for Gear Cover	2
40	05067	Seal Ring, GP8160/GP8360	3	K3	05028	Gear Cover	1
40	06996	Seal Ring, GP8165/GP8365	3	K4	05029	Hexagon Hd Cntrsnc Screw	4
41	05276	Pressure Ring, GP8155/GP8355	3	K5	07381	Hexagon Socket Screw	8
41	05068	Pressure Ring, GP8160/GP8360	3	K6	08041	Washer	8
41	05117	Pressure Ring, GP8165/GP8365	3	K7	05030	Connection for Oil Cooler	1
42	05277	Sleeve, GP8155/GP8355	9	K8	06272	Copper Seal	6
42	05069	Sleeve, GP8160/GP8360	9	K9	07109	Plug, 1/2" BSP	2
42	06997	Sleeve, GP8165/GP8365	9	K10	05031	Connecting Branch	3
43	05278	Sleeve Support Ring, GP8155/GP8355	3	K11	05032	U-Joint Connector c/w Nut	3
43	05070	Sleeve Support Ring, GP8160/GP8360	3	K12	05033	Tube for Cooler	2
43	05118	Sleeve Support Ring, GP8165/GP8365	3	K13	05402	Hose Clamp	4
				K14	05403	Hose Guard	2
				K15	05404	Hose Coupling Nut	1
				K16	05405	Flat Gasket	4
				K18	04158	Hexagon Socket Screw	4
				K19	05053	Washer	4

## Torque Specifications and Troubleshooting GP8155/GP8355/GP8160/GP8360/GP8165/GP8365

<b>TOOL LIST AND TORQUE SPECIFICATIONS</b>				
Item	Part #	Description	Torque Ft-Lbs (NM)	Tool Needed
17	05038	Hexagon Socket Screw	64 (87)	10mm Allen Wrench
24	05047	Connecting Rod Hex. Hd. Socket Screw	37 (50)	8mm Allen Wrench
33B	05054	Clip Ring	N/A	Industrial Snap Ring Pliers
36C	05062	Tension Screw	30 (40)	16mm Socket
49A	05073	Hexagon Nut (Manifold)	265 (360)	30mm Socket
51 & 52	05076 & 05082	Valve Assemblies	N/A	Valve Puller (p/n 07662) included w/pump
58	05087	Hexagon Socket Screw	132 (180)	12mm Allen Wrench
K5	07381	Hexagon Socket Screw	N/A	8mm Allen Wrench

<b>TROUBLESHOOTING</b>		
Problem	Cause	Solution
Pressure Drops, water leaks	V-sleeves leak	Replace V-sleeves, check surface of plunger
Pressure drops, pump gets loud	Discharge or suction valve leaks Steam formation (Cavitation)	Replace valve(s) Reduce suction height, reduce flow resistance in inlet line, clean inlet filter, lower water temperature.
Irregular pressure	Worn Valves	Examine valves
	O-ring on valves or inlet valve adapter leaks	Examine O-rings, check valve casing for unevenness on the sealing surfaces
Oil leaks at visible part of plunger	Gear sealing is leaking	Examine seals and running surface of plunger
Dirty, milk-colored or frothy oil	Water has mixed with oil	Replace oil immediately, find & fix the cause
Oil leakage on the crankshaft	Shaft seal ring leaks	Check seal and shaft
Noise increases without the loss	Worn bearing	Dismantle gear, examine all parts, replace worn parts, check oil level. If service life was too short, check for excess strain or whether lubrication intervals were too long. Only specified lubricants are to be used.

# GP8155/GP8355/GP8160/GP8360/GP8165/GP8365 Pump Repair Instructions

## Valve Inspection and Repair

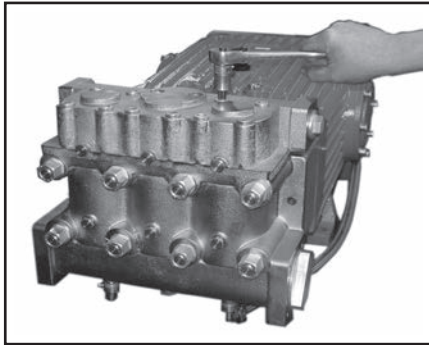

1) Remove socket head cap screws (58)

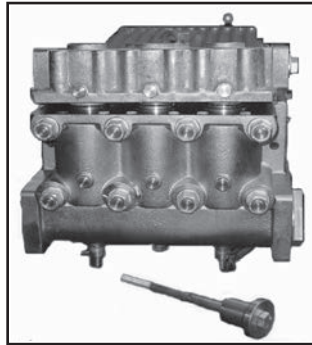

2) Lift discharge casing (50B) up and away.

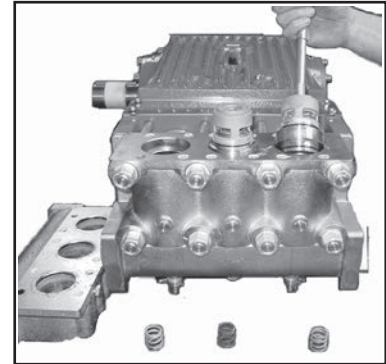

3) Take out pressure springs (57A). Pull out assembled valves (51 & 52) with valve puller.

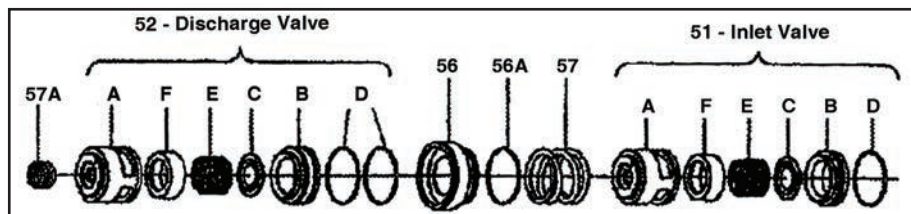

4) Remove valve assembly (52) from discharge valve adapter (56) by gently twisting apart. The spring tension cap (51A, 52A) is screwed together with the valve seat (51B or 52B). Remove spring tension cap. Takeout springs (51E, 52E) and valve plate (51C, 52C). Check sealing surfaces of valve plates (51C & 52C) and valve seats (51B & 52B) and O-rings (51D, 52D). Replace worn parts. Coat threads of valve seat with silicon grease or molycote anti-seize Cu-7439 when reassembling. Before refitting the valves, clean the sealing surfaces in the casing and check for any damage. Coat o-rings (51D, 52D & 56A) with silicone grease to help with re-assembly. Replace valve assembly (51) and pressure spring (57). Assemble valve assembly (52) to discharge valve adapter (56) by tapping together lightly with rubber mallet. While replacing the valve assemblies use a rubber mallet to tap the top of the valve puller lightly. This insures proper seating. Replace pressure spring (57A) and the discharge casing (50B). Tighten caps (58) at 132 Ft-lbs. (180 Nm); check torque tension after 8-10 operating hours.

## To Check Seals and Plunger Pipe

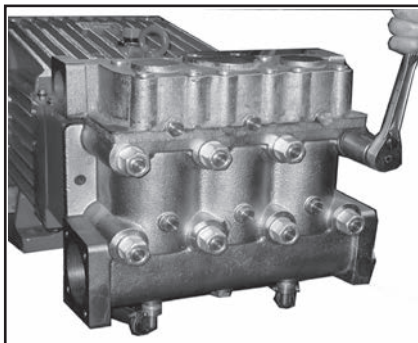

5) Remove hexagon nuts (49A) and valve casing together with seal case (38) from crankcase (1). If necessary, carefully tap the valve casing (50) past the centering stud (50A) using a rubber hammer.

**IMPORTANT!** If necessary, support the valve casing by resting it on wooden blocks or by using a pulley.

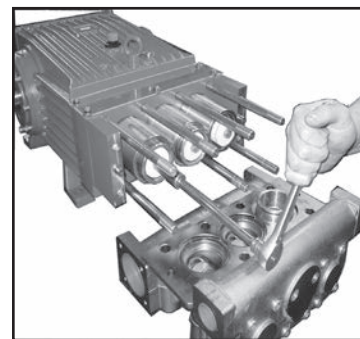

6) Remove tension screw (36C) and take seal sleeve (39) together with all mounted parts out of the drive. Pull plunger pipe (36B) out of the seal assembly and check for any damage. Carefully, remove seal rings (40) and sleeves (42) with a screwdriver.

# GP8155/GP8355/GP8160/GP8360/GP8165/GP8365

## Pump Repair Instructions

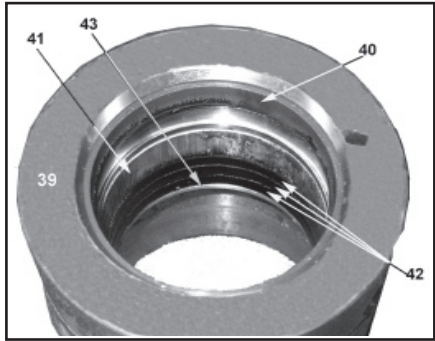

7) **Important!** Be careful not to damage the seal sleeve (39) and pressure ring (41). Check the inner diameter of the pressure ring for wear and if necessary replace together with seals (40) and (42). Clean all parts. New parts should be lightly coated with silicon grease before installation. Insert the seal unit (40, 41, 42 43) into the sleeve. Push the ceramic plunger carefully through the seals from the crankcase side. If necessary, the seals can be held tightly using a suitable pipe support held on the other side of the seal sleeve.

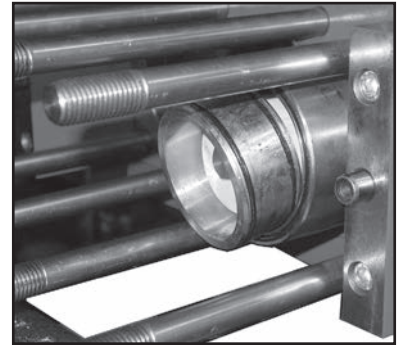

8) Take out the seal case (38) from the valve casing (50) and check o-rings (38A) (if necessary secure two screwdrivers in the front o-ring groove to extract seal casing from valve casing). Coat seals with silicon grease before installing.

**Important!** Mounting surfaces of the crankcase and the valve casing must be clean and free of damage. The components must lie exactly and evenly on one another. The same exactness applies for all centering positions in the crankcase, pressure and valve casing.

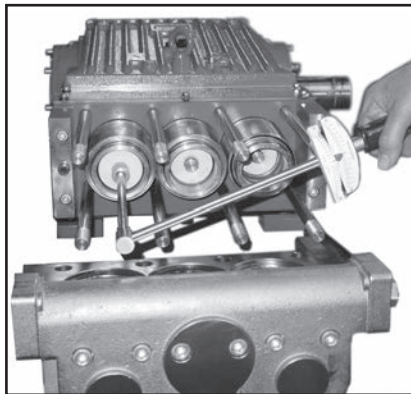

9) Coat the seal sleeve(39) lightly with anti-corrosive grease (e.g. molycote no.Cu-7439) in its fitted area towards the crankcase. Insert the seal sleeves in to their crankcase fittings. Coat the threads of the tension screw (36C) lightly with thread glue and insert it together with a new copper ring (36D) through the ceramic pipe. Turn the pump by hand until the plunger (25) rests against the plunger pipe. Tighten the tension screw at 30 Ft-lbs. (40 NM)

**Important!** Thread glue must never come between the plunger pipe (36B) and centering sleeve (36E). Overtensioning of the plunger pipe by excessive tightening of the tension screw and/or dirt or damage on the mounting surfaces can lead to plunger pipe breakage. Insert the seal tension spring (45) and o-ring (39A) in to the seal sleeve (39).

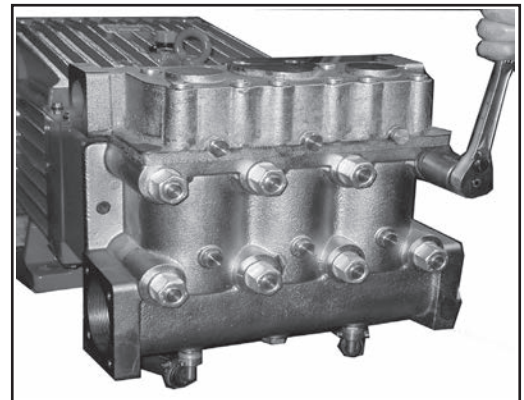

### Replacing Valve Casing:

10) Put seal cases (38) in the centering holes of the valve casing, then push valve casing carefully on to centering studs (50A). Tighten hexagon screws (49A) evenly and crosswise at 265 Ft.-lbs. (360 NM). Follow pattern below.

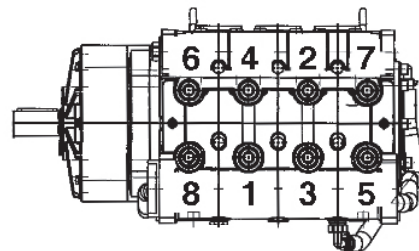

**Important!** The torque tension on the screws (49A) must be checked after 8-10 operating hours; the pump must be at zero pressure. Thereafter, the tension is to be checked every 200 operating hours.



# GP8155/GP8355/GP8160/GP8360/GP8165/GP8365

## Pump Repair Instructions

### To Dismantle Crankcase Gear

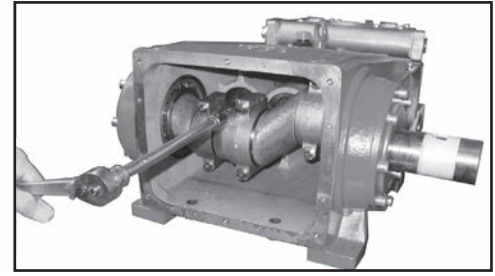
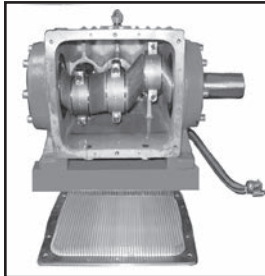
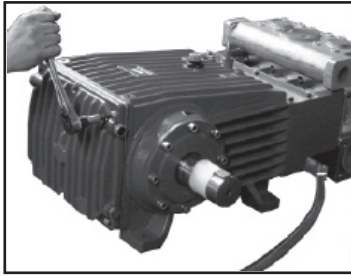

11) Take out plungers and seal sleeves as described above. Drain the oil by taking off the plug (12). After removing the clip ring (33B), lever out the seal retainer (33) and radial shaft seal (32) with a screwdriver. Open hose adapter (K11) and remove gear cover (K3) by removing the socket head cap screws (K5). Remove the cooling vane plate (K1) by removing the screws (K4)

12) Remove the connecting rod screws (24). **Important!** Connecting rods are marked 1 to 3 for identification. Do not rotate connecting rod halves or interchange them. When re-assembling, the connecting rod must be fitted in their exact original position on the crankshaft journals.

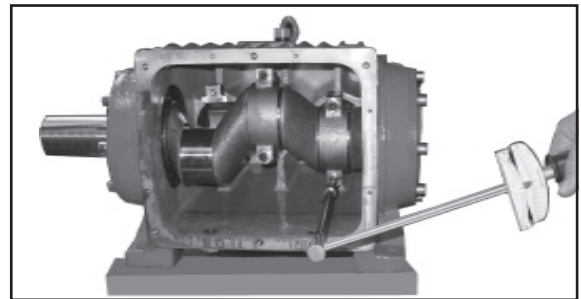
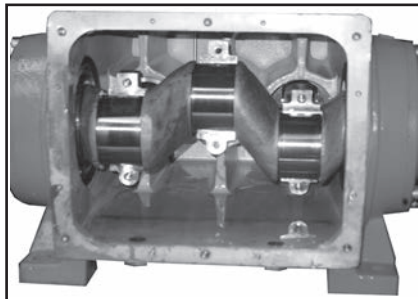

13) Push connecting rod halves together with the crosshead as far as possible into the crosshead guide. Remove bearing cover (14). Begin dismantling of the reduction gear by removing screws (67). Press off gear cover (66) by screwing two screws into both threaded bores. Remove screw (72) and take off fitting disc (69). Remove cogwheel from shaft with a removal tool and take the crankshaft (22) out of the crankcase (1) by gently tapping it with a rubber mallet. Remove connecting rod (24) and crosshead (25) from crankcase. Remember that this assembly must be re-assembled exactly as it was removed. Check surfaces on connecting rods (24), crankshaft (22) and crosshead (25). Check the surfaces of the crosshead guides in the crankcase for any unevenness.

14) Reassemble in reverse order. Replace the connecting rod and crosshead exactly as they were removed. Press the bearing ring (21) past the clip ring groove. Replace the shims (21C). Snap in the clip ring (19) and insert crankshaft from other side, then press in the roller bearing (20). Mount bearing cover (14) and tighten screws (17) to 64 Ft-lbs. (87 NM). Adjust axial play (clearance) on the crankshaft to minimum 0.1mm / 0.15mm using shims (21A/B). Connecting rods must sit exactly in the middle of the crankshaft journal. Mount connecting rod halves in the exact, original position and tighten to 37 Ft-lbs. (50 NM). The shaft should turn easily. **Important!** Connecting rods must be able to move slightly sideways on the stroke journals.



## GP8155/GP835/GP8160/GP8360/GP8165/GP8365 Pump Repair Instructions

15) Replace seal retainer (33), radial shaft seal (32) and clip ring (33B). Seal (32) must always be installed so the seal lip on the inside diameter faces the oil. Possible axial float of the seal retainer (33) is compensated by using shims (33C). Re-assemble the seal sleeves (39) and plunger pipes (36B). Tighten the tension screw (36C) to 30 Ft-lbs. Replace valve casing and tighten hexagon nuts (49A) evenly and cross-wise to 265 Ft-lbs. (360 Nm).

16) Mount cooling plate (K1) and gear cover (K3) with their respective seals (K2). When assembling the cooling circuit line, make sure that the oil cooler connection (K7) is always joined to the **upper** connection (K3) of the gear cover.

Heat ball bearings (74 and 75) first before pressing them on to the pinion. Press the cogwheel slightly on to the crankshaft (22) so that the pinion (69) together with the bearing (74) can be inserted.

Move the pinion (69) against the cogwheel and make them mate perfectly when mounting. Then carefully tap the cogwheel and the pinion simultaneously on to the crankshaft and into the bearing seat. Fit fitting disc (69) and secure screw (72) with Loctite. Fit the seal (76) on to the cylindrical pins (68).

Push the gear cover (66) carefully onto the bearing (75). Make sure that the radial shaft seal (73) does not get damaged during fitting onto the pinion.

**Important!** Before putting into operation again, turn the reduction gear shaft by hand at least four full turns to make sure the gear is correctly aligned.

### For Repair or Inspection of Reduction Gear

Remove screws (67). Pull off gear cover (66) by screwing two (2) screws into both thread bores. Remove screw (72) and take off fitting disc (69). Remove cogwheel from shaft with a removal tool and take the crankshaft out of the crankcase by gently tapping it with a rubber hammer.

Check the surfaces of the conn-rods (24), crankshaft (22) and crossheads (25). Check the surfaces of the crosshead guides in the crankcase for any unevenness.

Reassemble in reverse order. Adjust axial play (clearance) on the crankshaft to a minimum of 0.004" (0.1mm) / max. .006" (0.15mm) using shims (20C). Press the bearing ring (21) past the clip ring groove. Assemble in the clip ring and insert the crankshaft from the other side, then press in the roller bearing (20). The shaft should turn easily with little clearance. Replace the bearing cover (14) and tighten the screws (17) at 64 Lb-ft (87 Nm). Mount conn-rod halves into their exact original position and tighten to 37 Lb-ft (50 Nm).



# GIANT INDUSTRIES LIMITED WARRANTY

Giant Industries, Inc. pumps and accessories are warranted by the manufacturer to be free from defects in workmanship and material as follows:

1. For portable pressure washers and car wash applications, the discharge manifolds will never fail, period. If they ever fail, we will replace them free of charge. Our other pump parts, used in portable pressure washers and in car wash applications, are warranted for five years from the date of shipment for all pumps used in NON-SALINE, clean water applications.
2. One (1) year from the date of shipment for all other Giant industrial and consumer pumps.
3. Six (6) months from the date of shipment for all rebuilt pumps.
4. Ninety (90) days from the date of shipment for all Giant accessories.

This warranty is limited to repair or replacement of pumps and accessories of which the manufacturer's evaluation shows were defective at the time of shipment by the manufacturer. The following items are NOT covered or will void the warranty:

1. Defects caused by negligence or fault of the buyer or third party.
2. Normal wear and tear to standard wear parts.
3. Use of repair parts other than those manufactured or authorized by Giant.
4. Improper use of the product as a component part.
5. Changes or modifications made by the customer or third party.
6. The operation of pumps and or accessories exceeding the specifications set forth in the Operations Manuals provided by Giant Industries, Inc.

Liability under this warranty is on all non-wear parts and limited to the replacement or repair of those products returned freight prepaid to Giant Industries which are deemed to be defective due to workmanship or failure of material. A Returned Goods Authorization (R.G.A.) number and completed warranty evaluation form is required prior to the return to Giant Industries of all products under warranty consideration. Call (419)-531-4600 or fax (419)-531-6836 to obtain an R.G.A. number.

Repair or replacement of defective products as provided is the sole and exclusive remedy provided hereunder and the MANUFACTURER SHALL NOT BE LIABLE FOR FURTHER LOSS, DAMAGES, OR EXPENSES, INCLUDING INCIDENTAL AND CONSEQUENTIAL DAMAGES DIRECTLY OR INDIRECTLY ARISING FROM THE SALE OR USE OF THIS PRODUCT.

THE LIMITED WARRANTY SET FORTH HEREIN IS IN LIEU OF ALL OTHER WARRANTIES OR REPRESENTATION, EXPRESS OR IMPLIED, INCLUDING WITHOUT LIMITATION ANY WARRANTIES OR MERCHANTABILITY OR FITNESS FOR A PARTICULAR PURPOSE AND ALL SUCH WARRANTIES ARE HEREBY DISCLAIMED AND EXCLUDED BY THE MANUFACTURER.



GIANT INDUSTRIES, INC., 900 N. Westwood Ave., Toledo, Ohio 43607  
PHONE (419) 531-4600, FAX (419) 531-6836, [www.giantpumps.com](http://www.giantpumps.com)  
© Copyright 2016 Giant Industries, Inc.

03/16 GP8155\_GP8160\_GP8165.indd