

K55000-5G Triplex Plunger Pump

P54

- ◆ Flow rate is based on 100% volumetric efficiency and 68° F (20° C) ambient temperature.
- ◆ Depending on fluid medium, a minimum inlet pressure is required.
- ◆ Depending on rod loading, speed range = 10-100%.
- ◆ Gear dynamically balanced
- ◆ Gear with force-fed lubrication with oil cooler.
- ◆ Standard Gear Ratios: $i = 3.30, 3.95, 4.66$ and 5.63
- ◆ Weight: 4850 lbs (2200 kg)
- ◆ API 674 specifications (maximum 380 RPM) and vertical operation available upon request.
- ◆ Contact your local distributor or Giant Industries for use with special mediums. i.e. seawater, glycol, methanol, oil, etc.

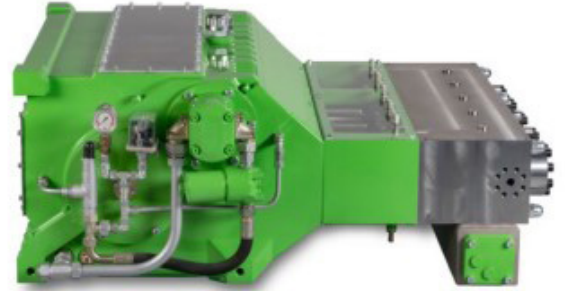
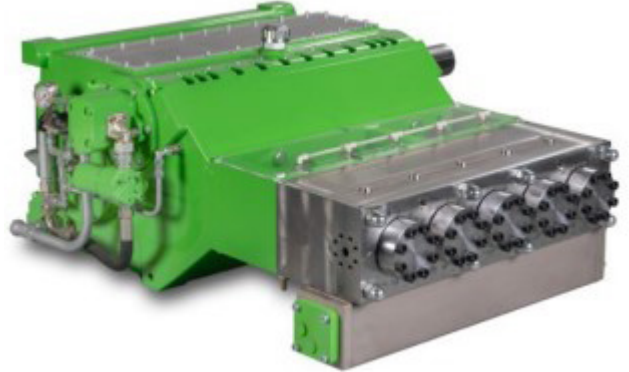

Rated Speed 450 RPM			Pressure at specific power inputs								Pump Head Style		
Type	FLOW		536 Hp	400 kW	604 Hp	450 kW	671 Hp	500 kW	738 Hp	550 kW	A	M	M2
	GPM	L/min	PSI	Bar	Hp	kW	Hp	kW	Hp	kW			
55018	18.2	69	44745	3085	50401	3475	50764	3500	-----	-----	1		
55020	22.5	85	36260	2500	40829	2815	45325	3125	49894	3440	1		
55022	27.2	103	29951	2065	33722	2325	37493	2585	41191	2840	1		
55024	32.2	122	25164	1735	28355	1955	31474	2170	34665	2390	1		
55026	37.8	143	21466	1480	24149	1665	26832	1850	29516	2035	1		
55028	43.9	166	18493	1275	20813	1435	23134	1595	25455	1755	1		
55030	50.5	191	16099	1110	18130	1250	20161	1390	22191	1530	2		
55032	57.3	217	14141	975	15954	1100	17695	1220	19508	1345	2		
55036	72.7	275	11168	770	12618	870	13996	965	15374	1060	2	1	
55040	89.6	339	9065	625	10225	705	11313	780	12473	860	2	1	
55045	113.3	429	7179	495	8050	555	8920	615	9863	680	2	1	
55050	140.0	530	5802	400	6527	450	7252	500	7977	550	2	1	
55055	169.3	641	4786	330	5366	370	6019	415	6599	455		1	
55060	201.6	763	4061	280	4569	315	5004	345	5512	380		1	
55065	236.4	895	3408	235	3844	265	4279	295	4714	325		1	
55070	274.5	1039	2973	205	3336	230	3699	255	4061	280			1
55075	314.9	1192	2611	180	2901	200	3191	220	3553	245			1
55085	404.5	1531	2031	140	2248	155	2538	175	2756	190			1
55090	453.6	1717	1813	125	2031	140	2248	155	2466	170			1
55095	505.4	1913	1595	110	1813	125	2031	140	2176	150			1



WARNING: This product might contain a chemical known to the State of California to cause cancer, and birth defects or other reproductive harm. For more information go to www.P65Warnings.ca.gov

K55000-5G Triplex Plunger Pump

P54

Pump Dimensions - mm(in)

Type A1

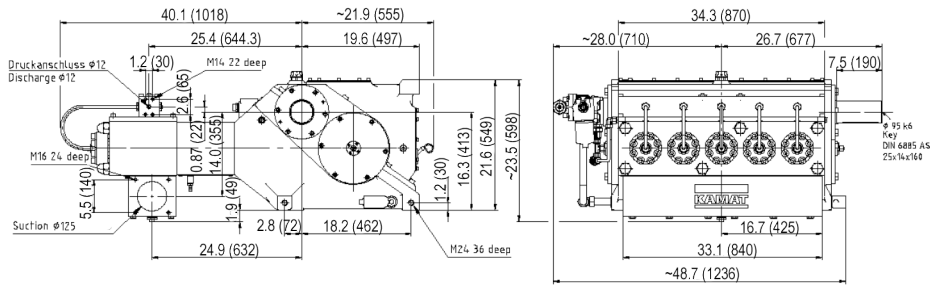

Type A2

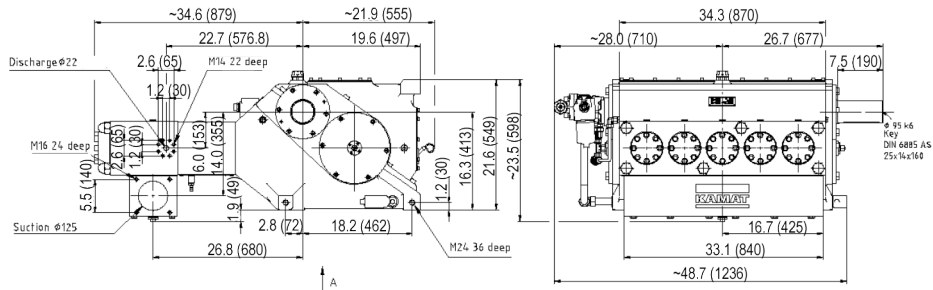

Type M1

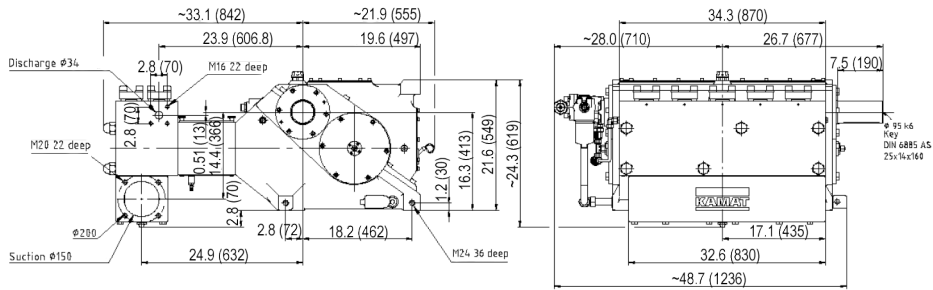

Type M21

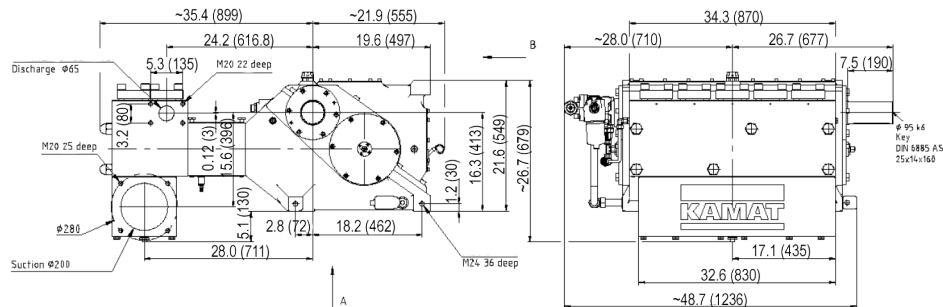

Type A1
≥ 21,755 PSI
(1500 bar)

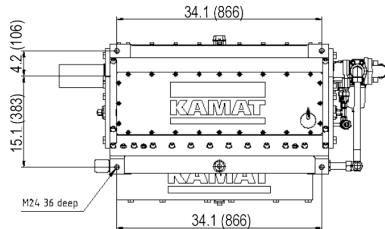

Footprint

